



TE-5S-MD

DIMENSIONAL SCHEMATIC, PERFORMANCE AND PARTS LIST

DIMENSIONS mm

not to scale
specifications are subject to change

Inlet: 1" BSP.F
Outlet: 1/2" BSP.M

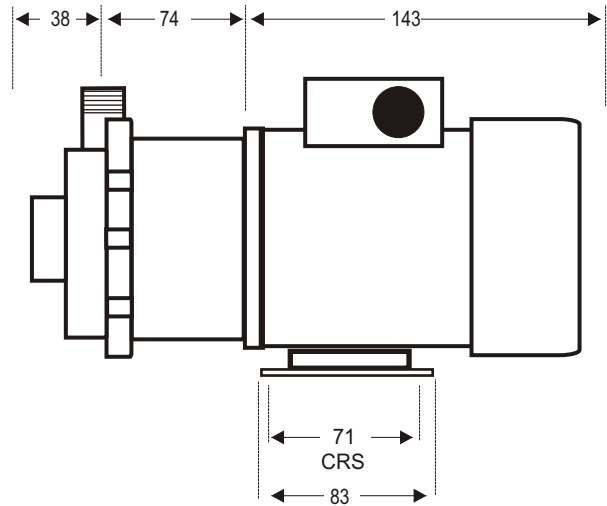
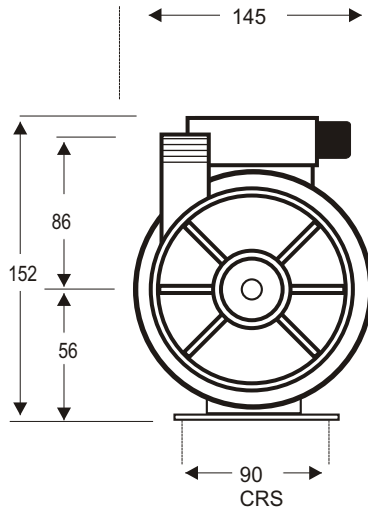

Details may change depending upon the motor specified

PARTS LIST

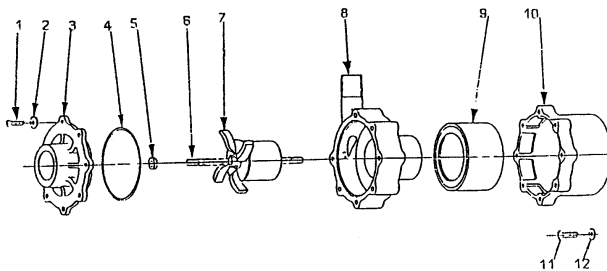

ITEM	DESCRIPTION	NOS	CODE
1	HOUSING SCREWS ST/STEEL	7	0150-101-UK
2	HOUSING WASHERS ST/STEEL	7	0150-200-UK
3	COVER ST/STEEL	1	0150-111-00
4	'O' RING PTFE	1	0135-136-UK
5	THRUST WASHER	1	130-028-UK
6	SPINDLE ST/ST	1	5021-230-51
7	IMPELLER ASSY ST/ST 2.75	1	0150-114-04
7a	CARBON BUSHING	1	0150-063-10
8	PUMP HOUSING ST/STEEL	1	0150-110-00
9	DRIVE MAGNET (9mm) HIGH TORQUE	1	0150-178-01
10	MOTOR BRACKET C/W INSERTS	1	0001-051-UK
11	BRACKET FIXING SCREWS	4	0130-100-UK
12	BRACKET FIXING WASHERS	4	0135-200-UK
14	WET END ASSY ITEMS 1-8		005-555-21
15	PUMP HEAD ASSY ITEMS 1-12		P050-555-21

PERFORMANCE

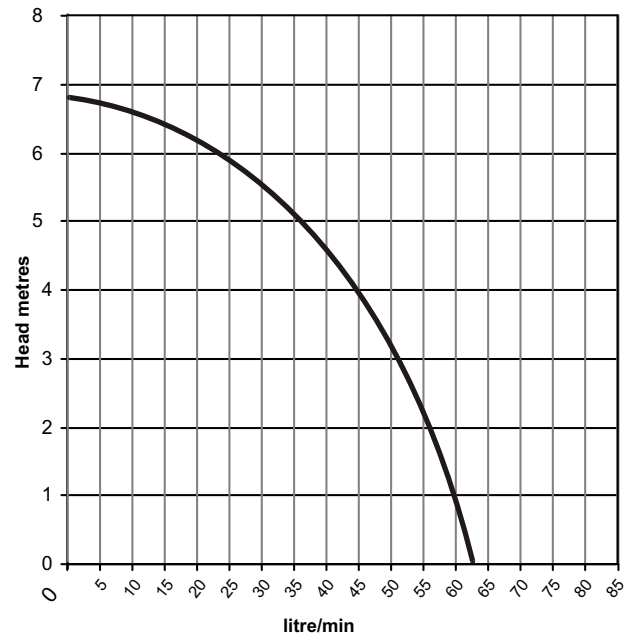

Tests obtained with water 1.0 SG

— 50 hz 2900 rpm