



MSP-2-24v dc brushless

DIMENSIONAL SCHEMATIC, PERFORMANCE AND PARTS LIST

DIMENSIONS mm

not to scale
specifications are subject to change

Ports: 1/2" BSP
3/4" BSP
15 mm push fit

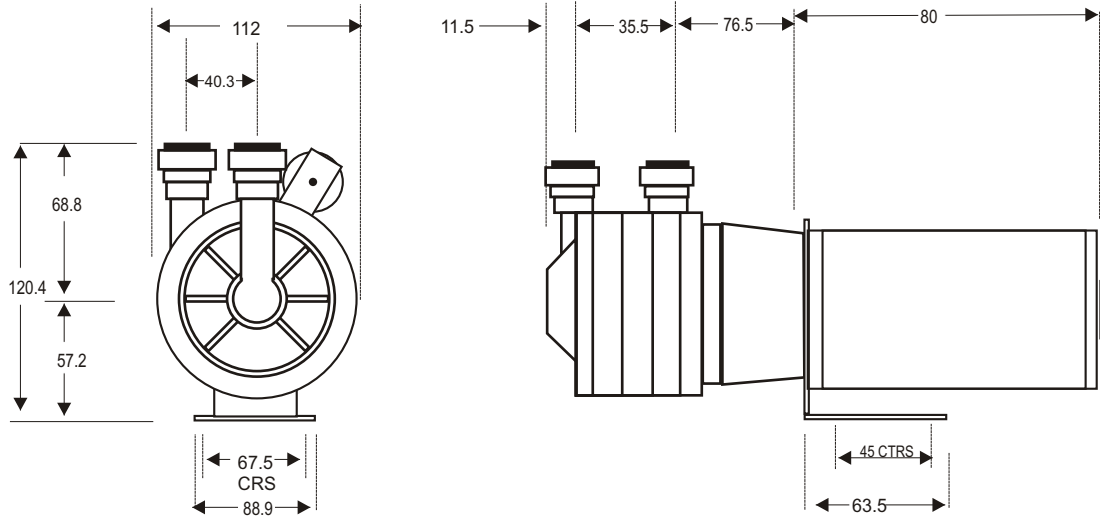

Details may change depending upon the motor specified

Motor: Dunkermotren BG 65x25KI

PARTS LIST

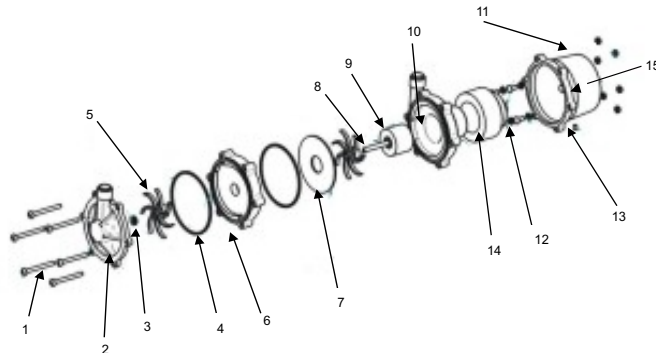

ITEM DESCRIPTION	NOS	CODE
1 M5 x 55 Pozi Pan Screw St Stl Set	6	5021-2112-50
2 MSP Front Cover PP JG	1	5020-110-01
MSP Front Cover PP 1/2" NPTM	1	5020-111-01
MSP Front Cover PP 3/4" BSPM	1	5020-112-01
3 Washer Thrust Ceramic	1	0130-028-UK
4 O Ring Id 87, 3mm C/Sec Nitrile	2	5020-122-30
5 Impeller PPS	2	5021-130-08N
6 Stage Housing	1	5020-150-01
7 Backing Plate	1	5020-160-13
9 Impeller magnet PPS	1	5021-191-08
8 Spindle St Stl 80mm	1	5021-231-51
10 MSP Pump Housing PP JG	1	5020-140-01
MSP Pump Housing PP 1/2"NPTM	1	5020-141-01
MSP Pump Housing PP 3/4"BSPM	1	5020-142-01
11 Full Nut M5 St Stl Set	6	5021-180-50
14 Drive Magnet	1	5021-202-60
12 Screw M5 x 12 Pozi Pan St Stl Set	4	5021-2212-50
13 Washer M5 Shakeproof St Stl Set	4	0135-200-UK
15 MSP Bracket PP	1	5020-170-01

PERFORMANCE

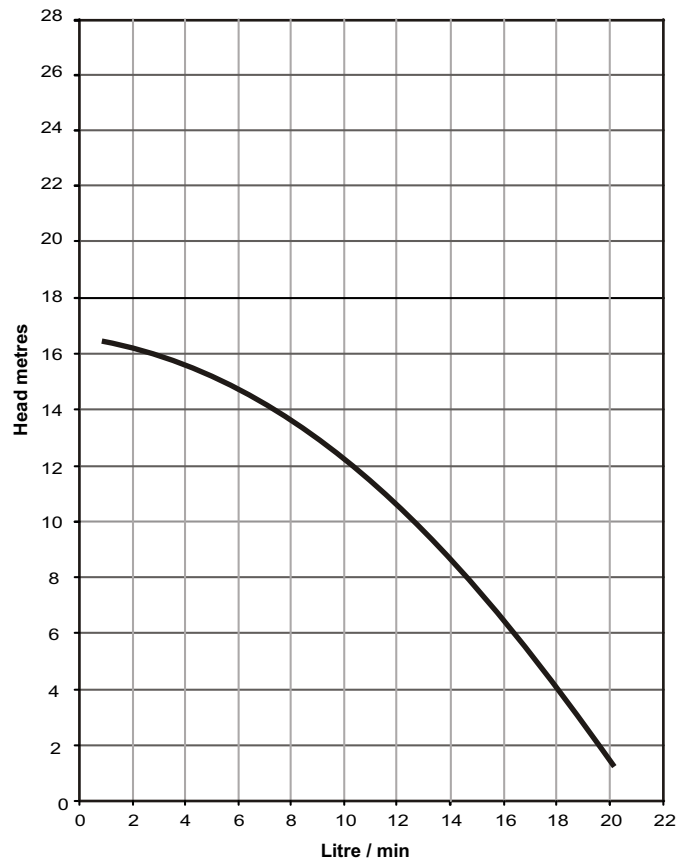

Tests obtained with water 1.0 SG

— 24v 3000 rpm