



MMP-3

DIMENSIONAL SCHEMATIC, PERFORMANCE AND PARTS LIST

DIMENSIONS mm

not to scale
specifications are subject to change

Ports: 3/8" BSP female

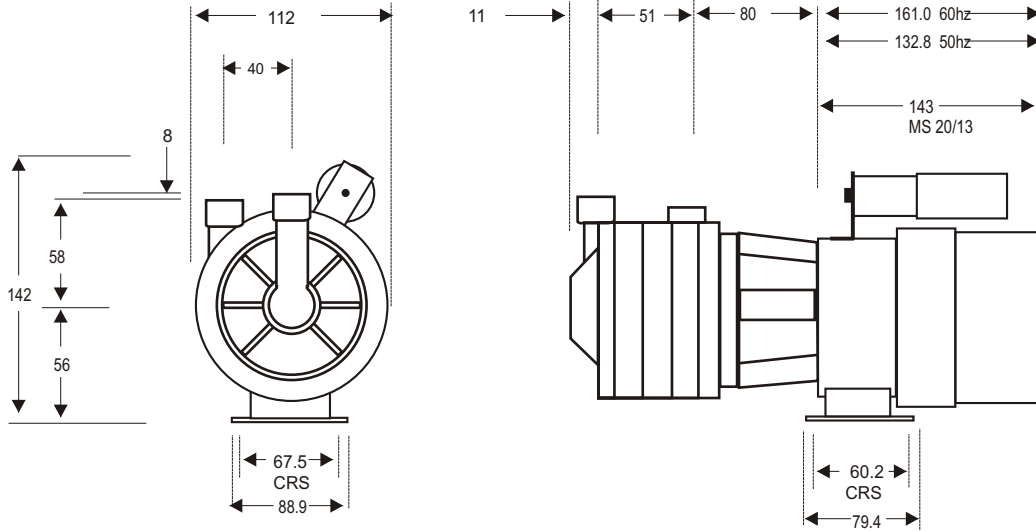

Details may change depending upon the motor specified

PARTS LIST

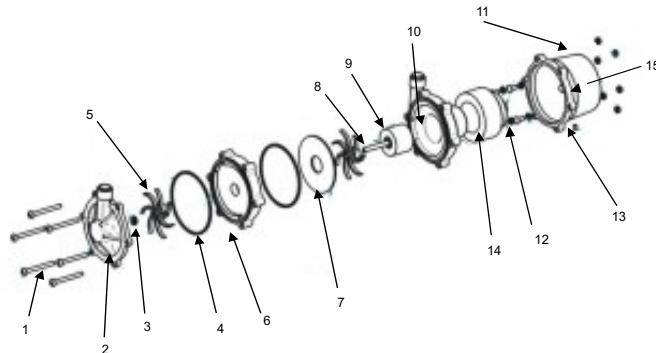

ITEM	DESCRIPTION	NOS	CODE
1	BRACKET IXEF	1	5021-170-11
2	DRIVE MAGNET ASSY FERRITE.IXEF	1	5021-201-11
3	PUMP HOUSING (BLUE)ACETAL	1	5021-140-10
4	IMPELLER MAGNET FERRITE/PPS	1	5021-191-08
5	"O" RING NITRILE (FQ)	3	5021-123-30
6	BACKING PLATE (WHITE) ACETAL	2	5021-160-02
7	STAGE HOUSING (BLUE) ACETAL	2	5021-150-10
8	IMPELLER PPS	3	5021-130-08
9	SPINDLE 316 SS	1	5021-231-51
10	WASHER -THRUST CERAMIC	1	0130-028-UK
11	FRONT COVER (BLUE) ACETAL	1	5021-110-10
	WET END ASSY ITEMS 3-11 INCLUSIVE	1	5021-102-10
A	BRKT/MTR SCREW CHSHD M5 x 12 SS	4	5021-221-50
Aa	WASHER S/PROOF M5 SS	4	0135-200-UK
2a	SOC/SET SCREW M5 x 6 STL	2	5021-500-56
B	PUMP BRKT SCREW M5 x 55 SS	6	5021-211-50
Bb	FULL NUT M5 x SS	6	5021-180-50

PERFORMANCE

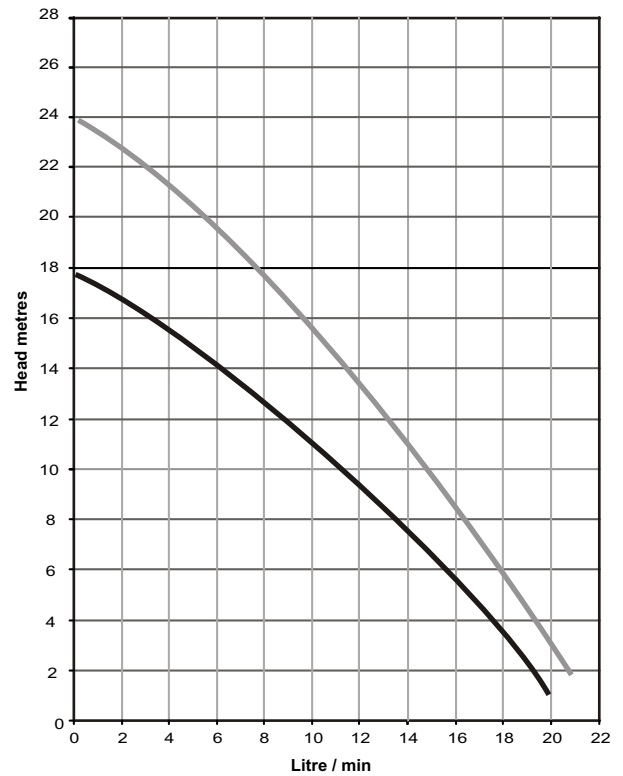

Tests obtained with water 1.0 SG

— 50 Hz 2900 rpm
— 60 Hz 3400 rpm